

# INSTRUCTION MANUAL

---

## Oil Free Vacuum Pump and Compressor

---

### Model No.

Rocker 300 / 300DC / 400 / 410

Rocker 900 / 901 / 910 / 911

Rocker 430

Tech support

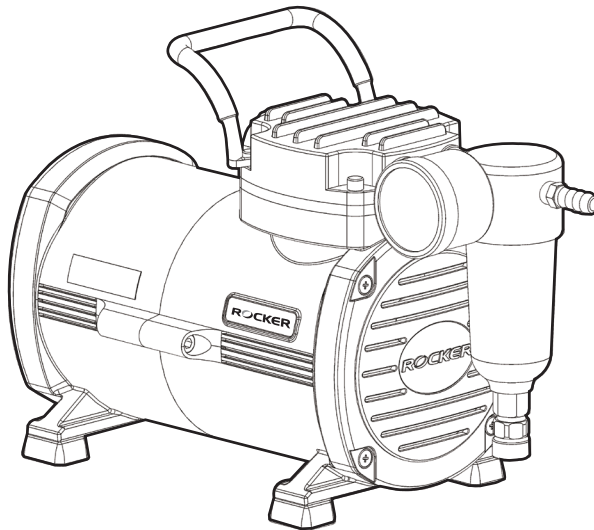

# ROCKER

Please read this instruction manual before using this product.



# Table Of Contents

<b>1.</b>	<b>Important Notice</b>	<b>1</b>
<b>2.</b>	<b>Unpacking</b>	<b>2</b>
<b>3.</b>	<b>Main Part Diagram</b>	<b>3</b>
	(1) Vacuum Pump	3
	(2) Vacuum Pump and Compressor	5
<b>4.</b>	<b>Operation</b>	<b>6</b>
<b>5.</b>	<b>Maintenance</b>	<b>7</b>
<b>6.</b>	<b>Troubleshooting</b>	<b>7</b>

# 1. Important Notice

This instrument is designed for laboratory usage only. Please read this manual carefully before installing and operating. The instrument shall not be modified in any way. Any modification will void the warranty and may result in potential hazard. We are not responsible for any injury or damage caused by any non-intended purposes and modifying the instrument without authorization.

1. Check the voltage specified on the name plate and ensure it matches the line voltage in your location.
2. Install the instrument in a clean, dust-less and ventilated area under 40°C.
3. Never use the instrument with any corrosive, chemical, flammable gas or toxic material.
4. Please connect the instrument with high-pressure hose or tubes.
5. The Prote™ filter cartridge can prevent a large amount of liquid from overflowing into the pump. Please ensure the liquid in the moisture trap not exceed safety level.
6. To ensure proper function of the Prote™ protection device, the pump must be installing on a flat level surface and should not be moved when operation. If the buoy closes during operation, it must be manually reset by uninstalling and reinstalling the filter cartridge.
7. The filter cartridge is used to absorb moisture and block dust. Please replace the cartridge to maintain pumping efficiency when it becomes dirty or color-changing.
8. The instrument is not designed to start against applied vacuum / pressure. To prevent damage, verify that the inlet and outlet are at atmospheric pressure before each start. If necessary, the inlet (and outlet of Rocker 430) can be vented to atmosphere by partially unscrewing the regulator knob.
9. This instrument has a thermal protection device that automatically shuts-off when it becomes overheated.
10. The temperature of the instrument surface is very high after use or during work, please don't touch it to avoid being burnt.
11. The instrument must not be used to create vacuum and pressure simultaneously.
12. Do not use any lubricant, which may damage the instrument.
13. If the supply cord is damaged, please contact the manufacturer or your service agent for replacement to avoid hazard.

14. Please discard packing material according to local related regulations.
15. Operating condition
  - (a) Ambient temperature: 5~ 40°C
  - (b) Relative humidity: 80% RH Max.
  - (c) Power supply: 100-120V~, 50/60Hz or 200-240V~, 50/60Hz
  - (d) Altitude: up to 2000 m
  - (e) Pollution degree: II
  - (f) Indoor use



**Caution: Hot surface**

***\* Before operation, please check whether the compatibility of materials of pump head, valve plates and piston seal with used medium.***

● **Vacuum Pump**

-Pump head: Aluminum alloy      - Valve plates: FKM      - Piston seal: PTFE complex

● **Vacuum Pump & Compressor**

-Pump head: Aluminum alloy      - Valve plates: SUS      - Piston seal: PTFE complex

***\* Warning: While Rocker 430 is operated as a compressor, please ensure a 20-min break while every 30-min working to prevent the instrument shutdown from overheating.***

## 2. Unpacking

Please check if the package is complete without any damage before unpacking. When unpacking, please make sure you have all accessories that indicated on the list. If there is any problem, please keep the serial number along with packing case and contact your local distributor immediately for assistance.

### 3. Main Part Diagram

#### (1) Vacuum Pump

Rocker 300

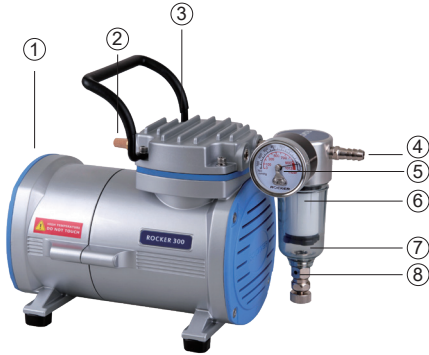

Rocker 300DC

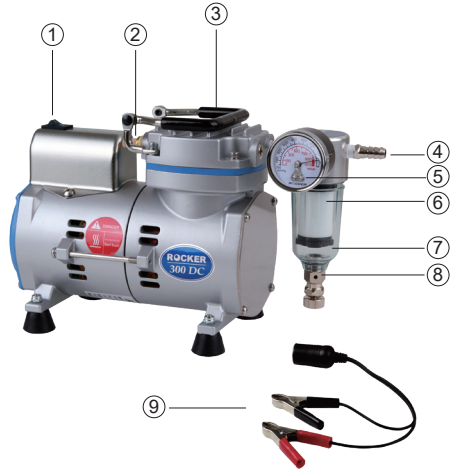

Position	Designation	Position	Designation
1	Power Switch	6	Prote™ Filter Cartridge
2	Air Outlet (Muffler)	7	Moisture Trap
3	Handle	8	Vacuum Regulator
4	Air Inlet	9	Power Cord
5	Vacuum Gauge		

\* The reference point of vacuum gauges is atmospheric pressure.

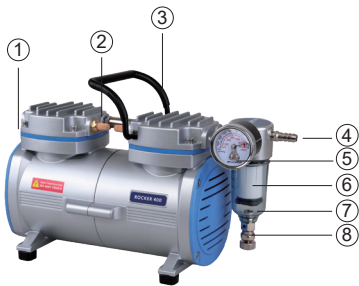

Rocker 400

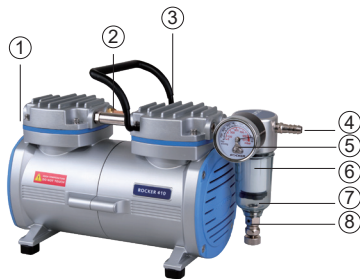

Rocker 410

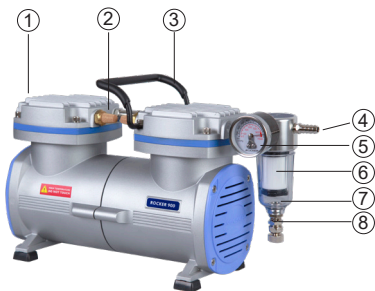

Rocker 900

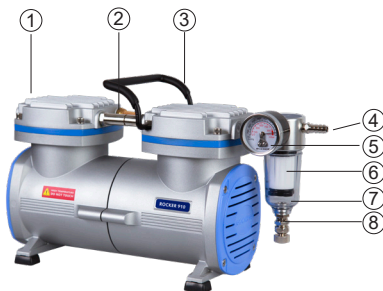

Rocker 910

Position	Designation	Position	Designation
1	Power Switch	5	Vacuum Gauge
2	Air Outlet (Muffler)	6	Prote™ Filter Cartridge*
3	Handle	7	Moisture Trap
4	Air Inlet	8	Vacuum Regulator

\* Rocker 900 / 910 is equipped with only filter cartridge, no Prote™ protection device.



Rocker 901



Rocker 911

## (2) Vacuum Pump and Compressor

Rocker 430



Position	Designation	Position	Designation
1	Power Switch	7	Moisture Trap
2	Air Outlet (Pressure Side)	8	Vacuum Regulator
3	Handle	9	Pressure Gauge
4	Air Inlet (Vacuum Side)	10	Filter Cartridge
5	Vacuum Gauge	11	Moisture Trap
6	Prote™ Filter Cartridge	12	Pressure Regulator (Drain Valve)

\* The reference point of both vacuum and pressure gauges is atmospheric pressure.



## 4. Operation

### • Operation

- A. Press power switch (1) to activate the instrument after making sure all tubing are well connected.
- A cold trap or trap bottle is recommended to connect before air inlet (4) of vacuum pump, while amount of moisture and steam exists.
  - A hoop holder is available to fix filtration apparatus securely and save space.
- B. To setup vacuum by adjusting the vacuum regulator (8).  
Pressure can also be set up on Rocker 430 by adjusting the pressure regulator (12).
- Pilot 100, vacuum controller (Cat. No. 183100-01(02)) is available for precise vacuum control.
- C. Check liquid level of moisture trap (7) daily and drain the liquid when it is up to the neck of bottle.

### \* Warning:

***(1) When pump is used for aqueous solution filtration, please ensure the liquid level of flask not exceed safety level. Failure to comply could result in serious damage to the pump and void the warranty. If it occurs, please contact the distributor immediately for service.***

***(2) While Rocker 430 is operated as a compressor, please ensure a 20-min break while every 30-min working period to prevent the instrument shutdown from overheating.***



Filtration System Assembly Diagram



Filtration System with Hoop Holder

## 5. Maintenance

1. Please remove the liquid in the moisture trap after every use and keep pumping the air for at least 2 minutes to withdraw the residual steam.
2. If the liquid in moisture trap is more than 70%, please stop the experiment immediately to empty the liquid.
3. The instrument is not autoclavable. Please clean the surface by pure water or 75% ethanol.
4. Please replace the cartridge to maintain pumping efficiency when it becomes dirty or color-changing.
5. Valve plate(s), O-ring(s) and silicone tube(s) are consumables, it is recommended to replace it on a yearly basis or as needed to ensure good operation.

### • How to reset the Prote™ protection device

1. Remove the moisture trap (7) and filter cartridge (6) by rotating clockwise.
2. Disassemble the filter cartridge (6) to ensure the buoy is not closed.
3. Reinstall all components, filter cartridge and moisture trap back.

### • How to replace cartridge

1. Please replace the cartridge when it becomes dirty or color-changing.
2. Please remove the moisture trap (7 / 11) by rotating it clockwise.
3. Replace the cartridge by the same way.

## 6. Troubleshooting

Problem	Reason and Solution
Failed to start	<ul style="list-style-type: none"><li>• Loose plug → Reconnect plug to power supply.</li><li>• Wrong voltage → Reconnect to power specified on name plate.</li><li>• Vacuum or pressure exists → Release vacuum / pressure and restart.</li><li>• Switch is broken → Contact distributor for assistance.</li></ul>
Poor vacuum / pressure	<ul style="list-style-type: none"><li>• Improperly vacuum / pressure setting → Adjust the regulator.</li><li>• Faulty gauge → Replace a new gauge.</li><li>• Air leakage → Replace or tighten the tubing and accessories that possible leaks.</li></ul>

## 7. Ordering Information

167300-11(22)	Rocker 300 Vacuum pump, AC110V,60Hz (AC 220V,50Hz)
167300-00	Rocker 300DC Vacuum pump, DC12V
167400-11(22)	Rocker 400 Vacuum pump, AC110V,60Hz (AC 220V,50Hz)
167410-11(22)	Rocker 410 Vacuum pump, AC110V,60Hz (AC 220V,50Hz)
167430-11(22)	Rocker 430 Vacuum Pump / Compressor, AC110V,60Hz (AC 220V,50Hz)
167900-11(22)	Rocker 900 Vacuum pump, AC110V,60Hz (AC 220V,50Hz)
167901-11(22)	Rocker 901 Vacuum pump, AC110V,60Hz (AC 220V,50Hz)
167910-11(22)	Rocker 910 Vacuum pump, AC110V,60Hz (AC 220V,50Hz)
167911-11(22)	Rocker 911 Vacuum pump, AC110V,60Hz (AC 220V,50Hz)
183100-01(02)	Pilot 100, Vacuum Controller, AC100-240V adaptor, US plug (EU plug)
167300-37	Hoop Holder for Rocker 300 / 400 / 410 / 300C / 400C / 410C, applicable to apparatus w/ Max. diameter of 118 mm
189300-37	Hoop Holder for Rocker 300 / 400 / 410 / 300C / 400C / 410C, applicable to apparatus w/ Max. diameter of 103 mm
167301-06	Moisture trap / Vacuum regulator for Rocker 300 / 400 / 410 / 430
167301-07	Prote™ filter cartridge for Rocker 300 / 400 / 410 / 430
167300-42	Muffler (Air outlet) for Rocker 300 / 400 / 410
167801-06	Moisture trap / Vacuum regulator for Rocker 900 / 910
167801-07	Filter cartridge for Rocker 900 / 910 (without Prote™ overflow protection)
167600-42	Muffler (Air outlet) for Rocker 900 / 901 / 910 / 911
167320-06	Moisture trap / Pressure regulator for Rocker 320 / 420 / 430 (Pressure side)
167300-07	Filter cartridge for Rocker 320 / 420 / 430 (Pressure side)
167200-38	Silicone Tube, Ø 6 x 12 mm, 1 m
180300-68	Silicone Tube, Ø 8 x 14 mm, 2 m

### • Rocker Pump Repair Kit

167300-62-2	Rocker 300 repair kit	167900-62	Rocker 900 repair kit
167400-62-2	Rocker 400 repair kit	167901-62	Rocker 901 repair kit
167410-62-2	Rocker 410 repair kit	167910-62	Rocker 910 repair kit
167430-62-2	Rocker 430 repair kit	167911-62	Rocker 911 repair kit

**Rocker Scientific Co., Ltd.**

Tel: +886-2-26033311 Fax: +886-2-26036622

E-mail: [export@rocker.com.tw](mailto:export@rocker.com.tw) <https://www.rocker.com.tw>